

# service spaces

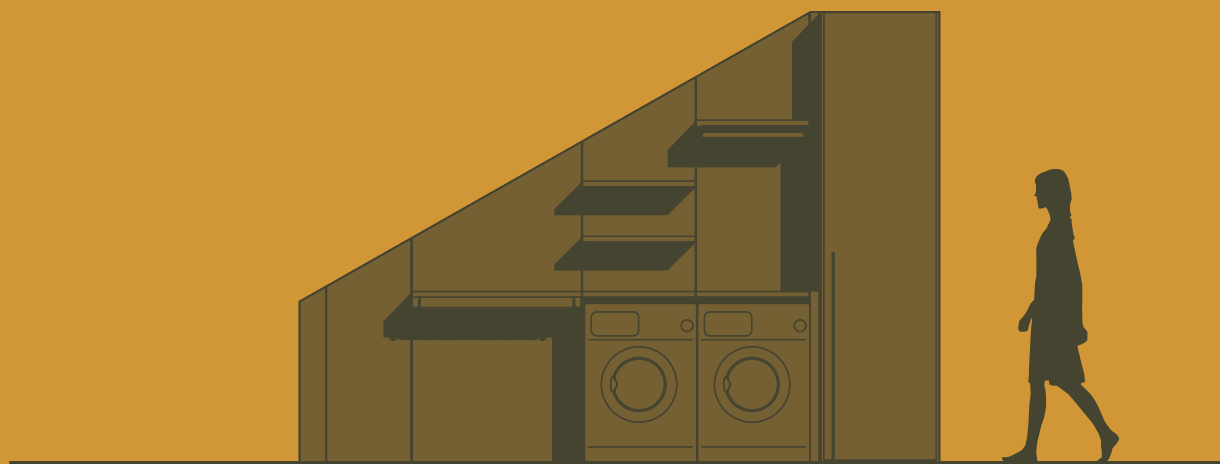

# service spaces

# indice

## index

### il sistema the system

**06** **funzionalità del sistema**  
system functionality

### lavanderia laundry

**16** **minimo ingombro, massima resa**  
small in size, big on performance

**30** **funzione in ogni dettaglio**  
function in every detail

**46** **soluzioni integrate, continuità visiva**  
built-in solutions, visual continuity

**64** **funzionalità in spazi di servizio inaspettati**  
functionality in unexpected service spaces

### locali di servizio service areas

**80** **dispensa: contenere con discrezione**  
pantry: unobtrusive storage

**96** **quando il corridoio diventa funzione**  
a hallway with a purpose

**108** **ripostiglio: organizzare con ordine**  
hall cupboard: a neat way to organize

### stanze accessorie bonus rooms

**122** **spazio per le passioni quotidiane**  
space for daily hobbies

**130** **comfort e praticità per gli ospiti**  
comfort and practicality for guests

**140** **postazione operativa in ambiente dedicato**  
workstation in dedicated office space

### pertinenze domestiche ancillary spaces

**154** **arredo funzionale per il garage**  
functional fitout for the garage

**168** **spazi tecnici da vivere**  
utilitarian spaces to be enjoyed

# il sistema the system

# Cinquanta3, il sistema

## Cinquanta3, the system



**Un sistema articolato di elementi d'arredo modulari, pensato per gestire con efficienza la quotidianità e ampliare con eleganza le potenzialità degli spazi domestici.**

A wide-ranging system of modular furniture, designed to make everyday life easier with efficient solutions and capitalize on the potential of domestic spaces with a touch of elegance.

### Sistema Cinquanta3: una risposta a ogni esigenza

Cinquanta3 system:  
catering to every need

**Il sistema Cinquanta3 evolve e compie un nuovo passo avanti. La proposta originaria, pensata per arredare ogni ambiente domestico, si arricchisce e si perfeziona: oggi è in grado di rispondere con ancora maggiore efficacia a qualsiasi esigenza funzionale, in ogni contesto abitativo.**

The Cinquanta3 system evolves, taking another step forwards. The original range, designed to furnish domestic spaces, has been added to and fine-tuned: today, it caters even more effectively to any functional requirement, in any home environment.

**lavorare**  
working

**riporre**  
stowing

**ottimizzare**  
optimizing

**esporre**  
displaying

**contenere**  
storing

**organizzare**  
organizing

# Cinquanta3, il sistema

## Cinquanta3, the system

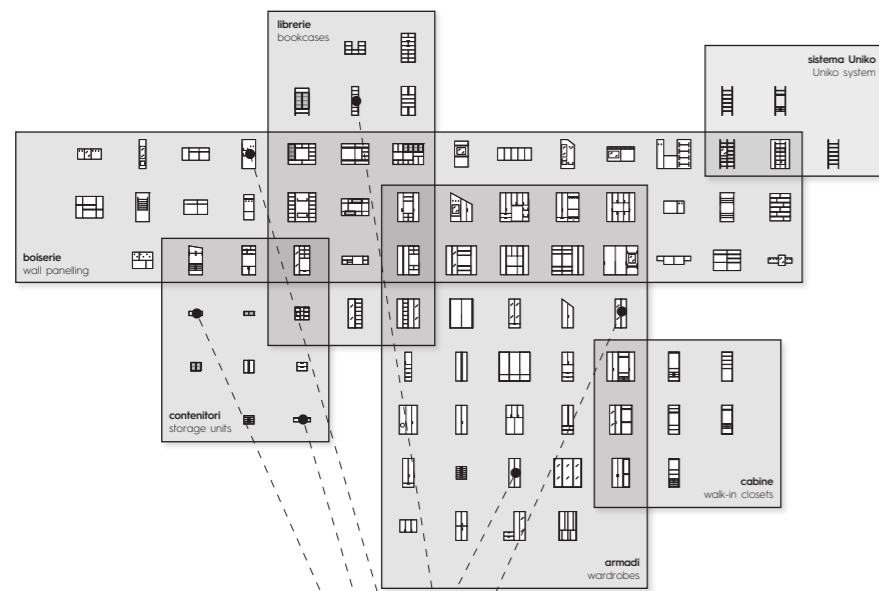

### Libertà compositiva

Endless configuration possibilities

**Elementi versatili danno forma a composizioni libere e dinamiche: l'arredo diventa espressione del vivere attuale, con soluzioni su misura che uniscono praticità e attenzione alla dimensione quotidiana.**

Versatile elements come together in dynamic configurations that play by your rules: the resulting furniture embodies the contemporary lifestyle, with practical solutions built around the needs of your day-to-day life.

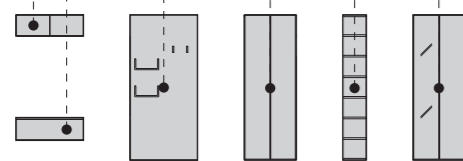

**singoli elementi del sistema**  
individual parts of the system

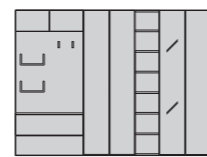

**composizione finita**  
finished configuration

### Funzione che si adatta

Adaptable functionality

**Il sistema Cinquanta3 nasce per offrire risposte concrete e versatili a ogni esigenza funzionale. Dall'organizzazione degli spazi al contenimento, ogni elemento è pensato per interpretare le necessità quotidiane con soluzioni flessibili e su misura, capaci di coniugare praticità ed estetica negli ambienti della casa più vissuti: lavanderia, locali di servizio, stanze accessorie e pertinenze domestiche.**

The Cinquanta3 system was conceived to offer versatile real-life solutions to every functional requirement. From organizing spaces to providing storage, each element has been designed to make daily life easier with flexible solutions tailored to individual needs, making the most high-use areas of the home – the laundry, service areas, bonus rooms and ancillary spaces – both practical and beautiful.

**Contenere**  
Storing



**Ottimizzare**  
Optimizing

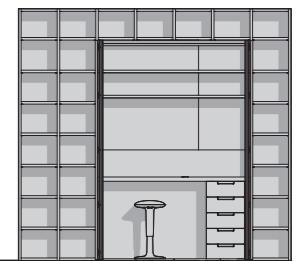

**Organizzare**  
Organizing

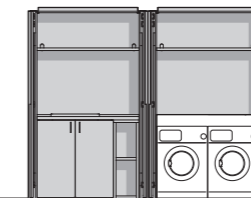

**Lavorare**  
Working

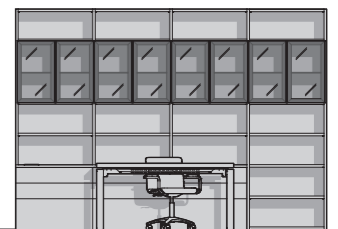

**Riporre**  
Stowing

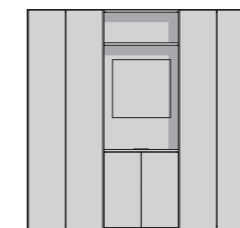

**Esporre**  
Displaying

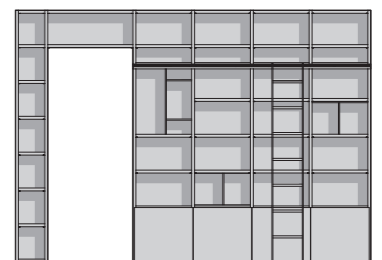

# Soluzioni funzionali per spazi dinamici.

Functional solutions for dynamic spaces.

**La funzionalità prende forma con libertà progettuale: ogni ambiente della casa – dalla lavanderia ai locali di servizio, dalle stanze accessorie alle pertinenze – è pensato per rispondere alle esigenze quotidiane, con soluzioni pratiche, versatili e su misura.**

Unlimited freedom to turn functional requirements into successful interiors: every space within the home – from the laundry to service areas, from bonus rooms to ancillary spaces – is designed to cater to daily needs, with practical, versatile solutions tailored to perfection.

**lavanderia**  
laundry

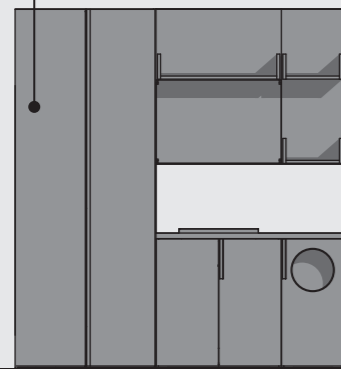

**locali di servizio**  
service areas



**stanze accessorie**  
bonus rooms

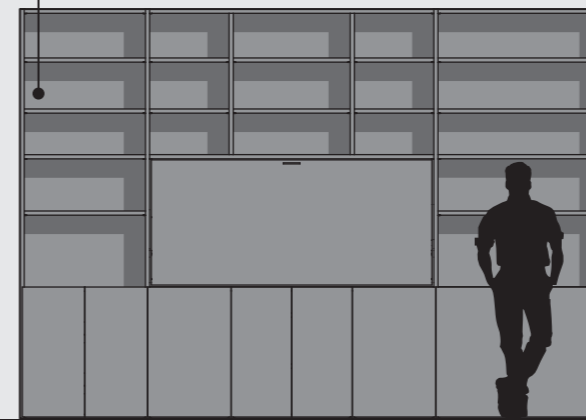

**pertinenze domestiche**  
ancillary spaces

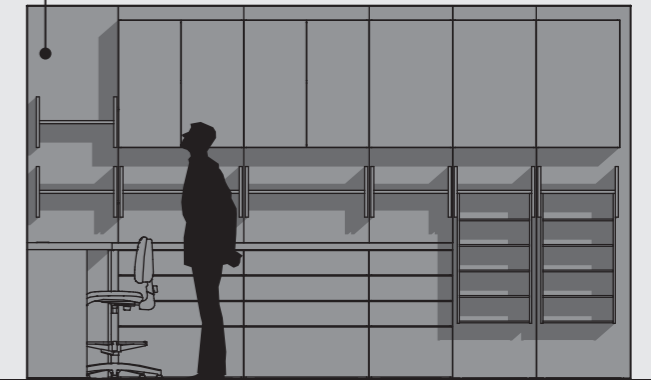

**lavanderia**  
laundry

lavanderia  
laundry

# Trova la soluzione perfetta per la tua lavanderia.

Find the perfect solution for your laundry.

## 01 - minimo ingombro, massima resa / small in size, big on performance



pag. 16



pag. 22



pag. 26

## 02 - funzione in ogni dettaglio / function in every detail



pag. 30



pag. 36



pag. 42

## 03 - soluzioni integrate, continuità visiva / built-in solutions, visual continuity



pag. 46



pag. 56



pag. 60

## 04 - funzionalità in spazi di servizio inaspettati / functionality in unexpected service spaces



pag. 64



pag. 68



pag. 72

**Minimo ingombro,  
massima resa.**  
Small in size,  
big on performance.

**Moduli salvaspazio e soluzioni estraibili danno forma a composizioni discrete e funzionali, ideali per ambienti dedicati o zone di passaggio. La funzione lavanderia si integra con eleganza, mantenendo ordine visivo e continuità formale. Un progetto essenziale, che coniuga praticità e coerenza estetica anche nei contesti più contenuti.**

Space-saving modules and pull-out solutions result in discreet and functional configurations, ideal for a dedicated room or transitional spaces. Elegantly incorporating all the functions of a laundry while offering a visual sense of order and formal continuity. A pared-back design that combines practicality and a cohesive look even in the tightest settings.





**elementi** / elements

**armadio Service battente** / hinged door Service cupboard  
**boiserie Cover** / Cover wall panelling  
**componenti Cover** / Cover components  
**specchio per boiserie** / mirror for wall panelling  
**top per lavabo** / sink top  
**lavabo da incasso** / drop-in sink  
**base lavabo** / sink base unit  
**base con oblò** / base unit with porthole

**finiture** / finishes

**gesso** / gesso  
**blu navy** / blu navy  
**bianco** / bianco  
**nuvola** / nuvola



**Soluzioni compatte, molteplici funzioni.**  
Compact solutions, multiple functions.



**elementi / elements**

**armadio battente** / hinged door wardrobe  
**libreria sospesa** / wall-mounted bookcase  
**top per lavabo con fianco a terra**  
sink top with floorstanding side panel  
**lavabo da incasso** / drop-in sink  
**base lavabo con oblò** / base unit with porthole

**finiture / finishes**

**nuvola** / nuvola  
**intonaco** / intonaco  
**bianco** / bianco

▼ **Dettaglio dell'asse da stiro estraibile.**  
Detail of pull-out ironing board.



**elementi / elements**

**armadio battente** / hinged door wardrobe  
**mensole Slim** / Slim shelves  
**top per lavabo con fianco a terra**  
sink top with floorstanding side panel  
**lavabo da incasso** / drop-in sink  
**base lavabo** / sink base unit

**finiture / finishes**

**cemento** / cemento  
**noce naturale** / noce naturale  
**juta** / juta  
**bianco** / bianco



**Sottoscala attrezzato: efficienza per spazi irregolari.**  
Functional under-stairs solution: efficiency for awkward spaces.



**elementi** / elements

**libreria a terra** / floorstanding bookcase

**cabina cremagliera** / slotted rail walk-in closet

**finiture** / finishes

**salvia** / salvia

**calce** / calce

**Soluzioni con contenimento visibile e integrato.**  
Solutions with visible and concealed storage.



**elementi / elements**

**armadio pieghevole** / folding door wardrobe  
**boiserie Cover** / Cover wall panelling  
**componenti Cover** / Cover components  
**piano di lavoro** / worktop  
**cesto portabiancheria su ruote**  
laundry basket on castors

**finiture / finishes**

**bianco** / bianco  
**canapa** / canapa  
**nuvola** / nuvola



**elementi / elements**

**sistema Uniko** / Uniko system  
**base a terra** / floorstanding base unit  
**top per lavabo** / sink top  
**base lavabo** / sink base unit  
**base con portabiancheria** / base unit with laundry hamper

**finiture / finishes**

**bianco** / bianco  
**basalto** / basalto  
**toulipier** / toulipier

▼ **Dettaglio dell'interno della base per lavatrice slim.**  
Detail of inside of base unit housing slim washing machine.



## Soluzione rialzata: più ordine e semplicità nella pulizia.

Raised solution: neater look and simpler cleaning.



elementi / elements

**libreria sospesa** / wall-mounted bookcase

**top per lavabo** / sink top

**base lavabo** / sink base unit

**basi in sovrapposizione** / base units sitting on legs

**gambe metalliche** / metal legs

finiture / finishes

**cashmere** / cashmere

**moka** / moka

**bianco** / bianco

▼ **Dettaglio del portascarpe estraibile.**  
Detail of pull-out shoe rack.





**elementi / elements**

- pensili / wall units**
- casellario / shelving unit**
- top per lavabo / sink top**
- lavabo da incasso / drop-in sink**
- base lavabo / sink base unit**
- base con portabiancheria e asse estraibile**  
base unit with laundry hamper and pull-out ironing board

**finiture / finishes**

- calce / calce**
- salvia / salvia**
- bianco / bianco**

**Sospesa o su piedini: varianti pratiche ed efficienti.**  
Wall-mounted or on feet: practical and efficient options.



**elementi / elements**

- boiserie Cover**  
Cover wall panelling
- componenti Cover**  
Cover components
- pensili / wall units**
- piano sp. 5 cm**  
5cm-thick top with floorstanding side panel

**finiture / finishes**

- nuvola / nuvola**
- lavagna / lavagna**

lavanderia  
laundry



**elementi / elements**

- libreria con gambe metalliche**  
bookcase with metal legs
- libreria ponte**  
bridging bookcase
- boiserie Arnad**  
Arnad wall panelling
- piano sp. 5 cm**  
5cm-thick top

**finiture / finishes**

- bianco / bianco**
- toulipier / toulipier**

## Funzione in ogni dettaglio.

Function in every detail.

Composizioni ad angolo e soluzioni su doppia parete definiscono ambienti dedicati alla cura del bucato, ottimizzati per funzionalità e ordine. Lavabi integrati, piani di lavoro continui e cesti estraibili si combinano a contenitori modulari, creando uno spazio pratico e ben organizzato. Anche in presenza di finestre, la configurazione si adatta con coerenza, valorizzando ogni superficie disponibile. Un linguaggio progettuale chiaro ed essenziale, dove l'efficienza quotidiana si traduce in equilibrio formale.

Corner configurations and galley solutions define rooms specifically designed for laundry chores, optimized for functionality and storage. Built-in sinks, uninterrupted worktops and pull-out hampers are teamed with modular storage units, creating a practical and well-organized space. Even with windows to work around, the configuration adapts cohesively, making the most of every available surface. A clear and pared-back design language, where daily efficiency translates into formal balance.





**elementi** / elements

- piano lavabo** / sink top
- lavabo da incasso** / drop-in sink
- asse in legno per lavabo** / wooden washboard
- base lavabo** / sink base unit
- libreria a terra e sospesa**  
floorstanding and wall-mounted bookcase
- boiserie Cover** / Cover wall panelling

**finiture** / finishes

- canapa** / canapa
- intonaco** / intonaco
- bianco** / bianco

**Soluzioni ad angolo per ottimizzare volumi e operatività.**  
 Corner solutions for optimized work and storage space.



**elementi / elements**  
**top lavabo con fianco a terra** / sink top with floorstanding side panel  
**lavabo da incasso** / drop-in sink  
**base lavabo** / sink base unit  
**modulo per robot aspirapolvere** / robot vacuum module  
**base ad angolo** / corner base unit  
**cesto portabiancheria su ruote** / laundry basket on castors  
**pensili** / wall units  
**boiserie Arnad** / Arnad wall panelling

**finiture / finishes**  
**nuvola** / nuvola  
**sabbia** / sabbia  
**bianco** / bianco



**elementi / elements**  
**top per lavabo** / sink top  
**lavabo da incasso** / drop-in sink  
**base lavabo** / sink base unit  
**basi in sovrapposizione** / base units sitting on legs  
**gambe metalliche** / metal legs  
**mensole sp. 3 cm** / 3cm-thick shelves  
**boiserie Arnad** / Arnad wall panelling  
**modulo angolo lineare** / straight corner unit  
**armadio ponte** / bridging wardrobe  
**ripiano sagomato** / shaped shelf  
**piano sp. 3 cm** / 3cm-thick top

**finiture / finishes**  
**bianco** / bianco  
**cemento** / cemento  
**toulipier** / toulipier  
**nuvola** / nuvola



lavanderia  
laundry

**Portali con ante rientranti: praticità e funzionalità.**  
Portals with pivot pocket doors: practicality and functionality.



**elementi / elements**

**cabina a spalla**

walk-in closet system with load-bearing side panels

**portali con ante rientranti**

portals with pivot pocket doors

**top per lavabo / sink top**

base lavabo / sink base unit

**libreria a terra / floorstanding bookcase**

mensole sp. 3 cm con LED / 3cm-thick shelves with LED

mensole sp. 3 cm / 3cm-thick shelves

**finiture / finishes**

bianco / bianco

**Pareti attrezzate a vista e contenimento per ambienti dedicati.**  
 Wall-to-wall functionality on proud display with storage options for dedicated rooms.



**elementi / elements**

- top per lavabo / sink top
- lavabo da incasso / drop-in sink
- base lavabo / sink base unit
- modulo per robot aspirapolvere / robot vacuum module
- pensili / wall units
- boiserie Arnad / Arnad wall panelling
- mensola sp. 5 cm con LED  
5cm-thick shelf with LED
- piano sp. 5 cm con fianco a terra  
5cm-thick top with floorstanding side panel
- base con oblò / base unit with porthole

**finiture / finishes**

- gesso / gesso
- blu navy / blu navy
- bianco / bianco



lavanderia  
laundry

▼ **Dettaglio della base con oblò.**  
 Detail of base unit with porthole.





**Boiserie Cover e libreria: equilibrio tra estetica, funzione e praticità.**  
 Cover wall panelling and bookcase: balancing looks, function and practicality.



lavanderia  
laundry

**elementi / elements**

- boiserie Cover /** Cover wall panelling
- componenti Cover /** Cover components
- piano di lavoro /** worktop
- mensole in metallo /** metal shelves
- libreria a terra /** floorstanding bookcase

**finiture / finishes**

- bianco /** bianco
- calce /** calce
- lavagna /** lavagna
- noce naturale /** noce naturale
- specchio chiaro /** light mirror
- vetro trasparente /** transparent glass



**Soluzioni ad angolo progettate per integrare la finestra.**  
 Corner solutions designed to accommodate a window.



▼ **Dettaglio della base ad angolo.**  
 Detail of corner base unit.



**elementi** / elements

**sistema Uniko** / Uniko system  
**top per lavabo** / sink top  
**lavabo da incasso** / drop-in sink  
**base lavabo** / sink base unit  
**base ad angolo** / corner base unit  
**base con oblò** / base unit with porthole  
**armadio Service pieghevole**  
 folding door Service cupboard

**finiture** / finishes

**bianco** / bianco  
**nuvola** / nuvola  
**salvia** / salvia  
**touliplier** / touliplier

## Varianti compositive all'insegna di efficienza e praticità.

Modular storage options with an emphasis on efficiency and practicality.



### elementi / elements

**top per lavabo con fianco a terra**  
sink top with floorstanding side panel

**lavabo da incasso** / drop-in sink

**base lavabo** / sink base unit

**base con portabiancheria e asse estraibile**

base unit with laundry hamper and  
pull-out ironing board

**base con oblò** / base unit with porthole

**base ad angolo** / corner base unit

**pensili** / wall units

**casellario** / shelving unit

### finiture / finishes

**bianco** / bianco

**basalto** / basalto

**canapa** / canapa



### elementi / elements

**armadio battente** / hinged door wardrobe

**pensile** / wall unit

**boiserie Arnad** / Arnad wall panelling

**mensole sp. 3 cm** / 3cm-thick shelves

**top per lavabo** / sink top

**base lavabo** / sink base unit

**base ad angolo** / corner base unit

### finiture / finishes

**bianco** / bianco

**intonaco** / intonaco

**moka** / moka

**juta** / juta



## Soluzioni integrate, continuità visiva.

Built-in solutions,  
visual continuity.

Soluzioni integrate e coerenti con l'arredo definiscono composizioni eleganti e funzionali, pensate per gli ambienti principali della casa. Moduli contenitivi e frontali coordinati celano la funzione lavanderia, garantendo ordine visivo e armonia stilistica. Un approccio progettuale discreto, che unisce operatività e design in un linguaggio sobrio, capace di dialogare con lo spazio senza interromperne la continuità.

Built-in solutions that fit in cohesively with the interior scheme result in configurations that are both elegant and functional, designed for the home's primary spaces. Storage modules and coordinated fronts conceal the laundry nook, delivering a visually neat result and harmonious design. A discreet design approach that combines a functional work area and attractive look in a restrained language, maintaining a dialogue and seamless continuity with the space.



La lavanderia vive nella cucina con discrezione.  
The laundry lives unobtrusively in the kitchen.

**elementi** / elements

**libreria a terra** / floorstanding bookcase  
**pensile** / wall unit  
**boiserie Cover** / Cover wall panelling  
**mensole sp. 3 cm** / 3cm-thick shelves  
**chiusura pieghevole** / folding closing system  
**armadio battente** / hinged door wardrobe  
**terminale libreria** / bookcase end unit  
**tavolo Nizza Small** / Nizza Small table  
**sedie Manila** / Manila chairs

**finiture** / finishes

**cashmere** / cashmere  
**nuvola** / nuvola  
**noce naturale** / noce naturale  
**bianco** / bianco  
**J00** / J00



**Un angolo spogliatoio che ottimizza lo spazio di servizio.**  
A walk-in cupboard designed to optimize the service space.



lavanderia  
laundry

elementi / elements

**angolo spogliatoio** / corner walk-in closet

**armadio battente** / hinged door wardrobe

**armadio ponte** / bridging wardrobe

**terminale libreria** / bookcase end unit

**tavolo circolare** / circular table

**sedie Sneek imbottite** / upholstered Sneek chairs

finiture / finishes

**nuvola** / nuvola

**lavagna** / lavagna

**noce naturale** / noce naturale

**astra CN51** / astra CN51

**Portale attrezzato con ante rientranti, per una fruizione totale.**  
Portal fitted with pivot pocket doors, providing full access.



**elementi / elements**

**portali con ante rientranti / portals with pivot pocket doors**  
**base con asse estraibile / base unit with pull-out ironing board**

**piano sp. 5 cm / 5cm-thick top**

**mensole sp. 5 cm / 5cm-thick shelves**

**libreria a terra / floorstanding bookcase**

**sgabelli Sneek / Sneek stools**

**finiture / finishes**

**toulipier / toulipier**

**intonaco / intonaco**

**bianco / bianco**

**J00 / J00**



**Dietro le colonne, la funzione tecnica.**  
Columns open to reveal hidden utility spaces.



**elementi** / elements

**armadio Service battente** / hinged door Service cupboard  
**modulo angolo lineare** / straight corner unit

**pensile** / wall unit  
**tavolo Corby** / Corby table  
**sedie Sneek imbottite** / upholstered Sneek chairs

**finiture** / finishes

**canapa** / canapa  
**nuvola** / nuvola  
**bianco** / bianco  
**lavagna** / lavagna  
**ruby CA01** / ruby CA01



lavanderia  
laundry

▼ **Dettaglio del ripiano estraibile.**  
Detail of pull-out shelf.



## Bagno e lavanderia in un unico spazio funzionale.

Bathroom and laundry all in one functional space.

**elementi** / elements

**armadio Service pieghevole**  
folding door Service cupboard

**finiture** / finishes

**lavagna** / lavagna  
**nuvola** / nuvola



lavanderia  
laundry

**Due cabine, due interpretazioni dello stesso spazio.**  
Two shower rooms, two different takes on the same space.



**elementi** / elements  
**cabina cremagliera**  
slotted rail walk-in closet  
**chiusura scorrevole**  
sliding closing system

**finiture** / finishes  
**bianco** / bianco  
**vetro laccato bianco**  
white lacquered glass

**elementi** / elements  
**cabina a spalla**  
walk-in closet system with  
load-bearing side panels  
**cesti portabiancheria su ruote**  
laundry baskets on castors  
**chiusura pieghevole**  
folding closing system

**finiture** / finishes  
**canapa** / canapa



**Il corridoio si trasforma in spazio di servizio.**  
The hallway is transformed into a service space.



▼ **Dettaglio dell'attrezzatura interna.**  
Detail of internal fittings.



lavanderia  
laundry

**elementi** / elements  
**armadio battente**  
hinged door wardrobe  
**finiture** / finishes  
**gesso** / gesso  
**juta** / juta



**Funzionalità discreta: chiusura pieghevole e armadio ponte.**  
 Low-key functionality: folding closing system and bridging wardrobe.



**elementi / elements**

- armadio battente / hinged door wardrobe**
- armadio ponte / bridging wardrobe**
- mensola sp. 3 cm / 3cm-thick shelf**
- moduli sottoponte con ante**  
modules under bridging unit with doors

**finiture / finishes**

- basalto / basalto**
- noce naturale / noce naturale**
- juta / juta**
- specchio chiaro / light mirror**

**elementi / elements**

- armadio Service pieghevole**  
folding door Service cupboard
- chiusura pieghevole**  
folding closing system
- franco chiusura / side panel on end**
- libreria a terra e sospesa**  
floorstanding and wall-mounted bookcase

**finiture / finishes**

- blu navy / blu navy**
- nuvola / nuvola**



## Funzionalità in spazi di servizio inaspettati.

Functionality in unexpected service spaces.

**Spazi di collegamento, ambienti di servizio o locali accessori: luoghi non convenzionali, dove l'organizzazione è essenziale. Le soluzioni di contenimento trovano qui una nuova applicazione, integrandosi in contesti non usuali come una veranda o un garage. Modularità e praticità si combinano a un'estetica pulita e coordinata, offrendo ordine e funzionalità anche negli spazi più tecnici.**

Connecting spaces, service areas or buffer zones: unconventional spaces where organization is key. Here, storage solutions find new applications, slotting into unusual settings like a veranda or garage. Modularity and practicality are combined with a clean, coordinated look, offering neat storage and functionality even in more utilitarian spaces.





**elementi / elements**  
**libreria con gambe metalliche**  
 bookcase with metal legs

**finiture / finishes**  
**salvia / salvia**  
**bianco / bianco**

**Modi diversi di vivere lo stesso spazio.**  
 Different ways to make use of the same space.



**elementi / elements**  
**piano di lavoro / worktop**  
**libreria sospesa / wall-mounted bookcase**

**finiture / finishes**  
**gesso / gesso**  
**blu navy / blu navy**



**elementi / elements**  
**sistema Uniko / Uniko system**  
**top per lavabo / sink top**  
**lavabo da incasso / drop-in sink**  
**asse in legno per lavabo / wooden washboard**  
**base lavabo / sink base unit**  
**piano sospeso con alzata**  
 wall-mounted top with upstand

**finiture / finishes**  
**bianco / bianco**

## Soluzioni su misura per organizzare lo spazio con ordine.

Custom solutions for a neatly organized space.

**elementi** / elements

**portale con ante rientranti**  
portal with pivot pocket doors

**pensili** / wall units

**base con portabiancheria**  
base unit with laundry hamper

**finiture** / finishes

**calce** / calce

**cashmere** / cashmere





**Ordine visivo e versatilità: chiusura pieghevole o soluzione a giorno.**  
 Versatility and a visual sense of order: folding closing system or open solution.



**elementi / elements**

- mensole sp. 5 cm / 5cm-thick shelves**
- top per lavabo / sink top**
- lavabo da incasso / drop-in sink**
- base lavabo con fianco a terra**  
sink base unit with floorstanding side panel
- asse in legno per lavabo**  
wooden washboard

**finiture / finishes**

- bianco / bianco**
- noce naturale / noce naturale**

**elementi / elements**

- cabina a spalla**  
walk-in closet system with load-bearing side panels
- chiusura pieghevole / folding closing system**
- top per lavabo / sink top**
- lavabo da incasso / drop-in sink**
- base lavabo / sink base unit**

**finiture / finishes**

- bianco / bianco**
- nuvola / nuvola**
- toulipier / toulipier**



## Lavanderia in garage: ordine, contenimento e funzionalità.

Laundry in the garage:  
organization, storage and  
functionality.

### ▼ Dettaglio dell'angolo spogliatoio. Detail of walk-in cupboard.



#### elementi / elements

**angolo spogliatoio** / corner walk-in closet  
**pensili** / wall units  
**casellario metallico** / metal shelving unit  
**base armadio con oblò**  
cupboard base unit with porthole  
**piano sp. 5 cm con fianco a terra**  
5cm-thick top with floorstanding side panel  
**boiserie Cover** / Cover wall panelling  
**componenti Cover** / Cover components

#### finiture / finishes

**cemento** / cemento  
**lavagna** / lavagna  
**nuvola** / nuvola

**Cabina e sistema Uniko: organizzare lo spazio di servizio con approcci diversi.**  
Walk-in and Uniko system: different approaches to organizing service spaces.



**elementi** / elements      **finiture** / finishes  
**cabina armadio** / walk-in closet      **nuvola** / nuvola



lavanderia  
laundry

**elementi** / elements  
**sistema Uniko** / Uniko system  
**armadio battente** / hinged door wardrobe  
**modulo angolo lineare** / straight corner unit  
**modulo sovrapponibile** / stackable module  
  
**finiture** / finishes  
**basalto** / basalto  
**lavagna** / lavagna  
**juta** / juta

▼ **Dettaglio dell'attrezzatura interna.**  
Detail of internal fittings.



# locali di servizio

service areas

# La soluzione per ogni spazio di servizio.

A solution for every service space.

## 05 - dispensa: contenere con discrezione / pantry: unobtrusive storage

---



pag. 80



pag. 90

## 06 - quando il corridoio diventa funzione / a hallway with a purpose

---



pag. 96



pag. 104

## 07 - ripostiglio: organizzare con ordine / hall cupboard: a neat way to organize

---



pag. 108

## Dispensa: contenere con discrezione. Pantry: unobtrusive storage.

La dispensa è uno spazio che si organizza in modo discreto ed efficiente grazie a stanze celate dall'arredo o nicchie attrezzate integrate nella composizione. Soluzioni che scompaiono alla vista ma rivelano una grande capacità contenitiva, pensate per tenere tutto in ordine e sempre accessibili. Questo approccio consente di ottimizzare lo spazio disponibile, mantenendo pulizia visiva e continuità con il linguaggio dell'ambiente circostante.

The pantry is a space that can be organized unobtrusively and efficiently by keeping rooms hidden behind fitted doors or incorporating a well-appointed alcove into the configuration. Solutions that disappear out of sight but open to reveal plenty of storage, designed to keep everything tidy and readily accessible. With this approach, you can optimize the available space, maintaining a visually sleek look and continuity with the language of its setting.



Dietro l'anta pieghevole, una dispensa organizzata.  
Folding doors open to reveal a well-organized pantry.





**elementi** / elements

- armadio battente** / hinged door wardrobe
- chiusura pieghevole** / folding closing system
- libreria a terra** / floorstanding bookcase
- mensole ad L** / L-shaped shelves
- sgabelli Sneek** / Sneek stools

**finiture** / finishes

- sabbia** / sabbia
- noce naturale** / noce naturale
- calce** / calce
- vetro fumé** / smoked glass
- lavagna** / lavagna
- sabbia** / sabbia
- nero** / nero
- J10** / J10





**La chiusura scorrevole come filtro tra gli spazi.**  
 A sliding closing system acts as a screen between spaces.



**elementi** / elements

**chiusura scorrevole** / sliding closing system

**cabina a spalla**  
 walk-in closet system with load-bearing side panels

**pensile** / wall unit

**basi a terra** / floorstanding base units

**finiture** / finishes

**bianco** / bianco

**vetro laccato nero** / black lacquered glass

**grafite** / grafite

**Dedicato e accessibile: uno spazio sempre a vista.**  
 A dedicated and accessible space: always on proud display.



**elementi / elements**

**armadio battente** / hinged door wardrobe  
**armadio ponte** / bridging wardrobe  
**terminale libreria** / bookcase end unit  
**boiserie Cover** / Cover wall panelling  
**componenti Cover** / Cover components  
**base a terra** / floorstanding base unit  
**mensole Slim** / Slim shelves  
**sgabelli Kyoto** / Kyoto stools

**finiture / finishes**

**toulipier** / toulipier  
**cemento** / cemento  
**intonaco** / intonaco  
**cemento** / cemento  
**toulipier** / toulipier  
**nero** / nero  
**J10** / J10

## Organizzazione nascosta in una nicchia dedicata.

Organization concealed  
inside a dedicated alcove.

▼ **Dettaglio dell'organizzazione con sistema Uniko.**  
Detail of organization using the Uniko system.



**elementi** / elements

**chiusura scorrevole** / sliding closing system

**sistema Uniko** / Uniko system

**boiserie Cover** / Cover wall panelling

**tavolo Corby** / Corby table

**sedie Sneek** / Sneek chairs

**finiture** / finishes

**bianco** / bianco

**intonaco** / intonaco

**noce naturale** / noce naturale

**bianco** / bianco

**J00** / J00

## Versatilità progettuale: la cabina diventa dispensa.

Design versatility: a walk-in closet turned pantry.



### elementi / elements

**armadio battente** / hinged door wardrobe  
**chiusura pieghevole** / folding closing system  
**cabina cremagliera** / slotted rail walk-in closet

### finiture / finishes

**noce naturale** / noce naturale  
**cashmere** / cashmere  
**nuvola** / nuvola  
**vetro trasparente** / transparent glass  
**lavagna** / lavagna



**Apertura scorrevole per ottimizzare lo spazio.**  
Sliding doors for optimizing space.



**elementi / elements**  
armadio scorrevole / sliding door wardrobe  
tavolo Corby / Corby table  
sedie Sneek / Sneek chairs

**finiture / finishes**  
bianco / bianco  
canapa / canapa  
gesso / gesso  
juta / juta  
basalto / basalto  
bianco / bianco  
J00 / J00



▲ **soluzione 1 / solution 1**

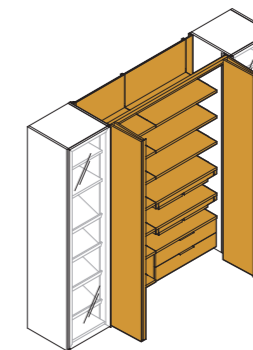

**Chiusura pieghevole**  
Folding closing system  
p. 92-93

◀ **soluzione 2 / solution 2**

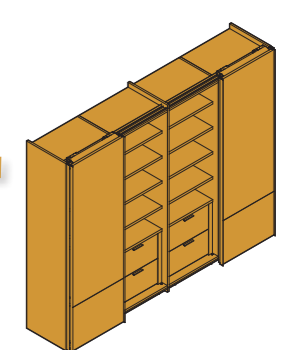

**Armadio scorrevole**  
Sliding door wardrobe

## Quando il corridoio diventa funzione.

A hallway with a purpose.

**Nel progetto d'interni, anche il corridoio può evolvere da semplice zona di transito a spazio pienamente funzionale. Attraverso arredi integrati, elementi su misura e volumi a tutta altezza, questo ambiente assume un ruolo attivo nell'organizzazione della casa. Le superfici si attrezzano con eleganza, offrendo soluzioni contenitive che si mimetizzano nell'architettura, mantenendo ordine e leggerezza visiva. Tra geometrie lineari e composizioni fluide, il passaggio si trasforma in un elemento progettuale capace di coniugare estetica e praticità quotidiana.**

In interior design, even the hallway can graduate from a mere circulation area to a fully functional space. Using built-in furniture, custom units and full-height storage, this area can play an active role in organizing the home. Surfaces are elegantly fitted out, offering storage solutions that blend into the architecture, maintaining order and a visually light feel. In a medley of linear geometries and easy-flowing configurations, the hall is transformed into a design feature with a masterful combination of aesthetic appeal and everyday practicality.



**Ante rientranti per un corridoio che cambia funzione.**  
Pivot pocket doors for a hallway that gets a new purpose.



**elementi / elements**

**portali con ante rientranti**  
portals with pivot pocket doors  
**libreria sospesa**  
wall-mounted bookcase  
**casellari metallici**  
metal shelving units  
**piani sp. 5 cm / 5cm-thick tops**  
basi a terra  
floorstanding base units  
**cassettiera in metallo su ruote**  
metal drawer unit on castors  
**sedia Nice / Nice chair**  
**divano Panama / Panama sofa**  
**tavolino Porto / Porto side table**

**finiture / finishes**

**calce / calce**  
**nuvola / nuvola**  
**lavagna / lavagna**  
**toulipier / toulipier**  
TL49 / TL49  
**chanel CR45 / chanel CR45**  
**blu navy / blu navy**

**Funzionalità discreta dietro una chiusura pieghevole.**  
 Functionality hidden discreetly behind a folding closing system.



**elementi / elements**

**libreria a terra e sospesa**  
 floorstanding and wall-mounted bookcase  
**chiusura pieghevole** / folding closing system  
**piano sospeso sp. 5 cm con alzata**  
 5cm-thick wall-mounted top with upstand  
**mensole sp. 3 cm / 3cm-thick shelves**  
**boiserie Arnad** / Arnad wall panelling  
**base a terra** / floorstanding base unit  
**sgabello Goa** / Goa stool  
**scrivania** / desk  
**sedia Cannes imbottita** / upholstered Cannes chair

**finiture / finishes**

**canapa** / canapa  
**cashmere** / cashmere  
**rovere cotto** / rovere cotto  
**specchio chiaro** / light mirror  
**aida CJ04** / aida CJ04  
**nero** / nero  
**TL45** / TL45  
**lavagna** / lavagna  
**TL49** / TL49



locali di servizio  
 service areas



## Postazione smartworking con sistema Uniko. Home workstation with Uniko system.



### elementi / elements

chiusura scorrevole / sliding closing system  
struttura armadio / wardrobe structure  
boiserie Cover / Cover wall panelling  
sistema Uniko / Uniko system  
pouf Austin / Austin ottoman

pensili / wall units  
casellari metallici / metal shelving units  
panca scendiletto in folding  
mitre-folded bed end bench  
seduta imbottita / padded seat

### finiture / finishes

lavagna / lavagna  
noce naturale / noce naturale  
specchio brunito / tinted mirror  
titanio / titanio  
ruby CA09 / ruby CA09

blu navy / blu navy  
noce naturale / noce naturale  
vika CE61 / vika CE61

### ▲ soluzione 1 / solution 1

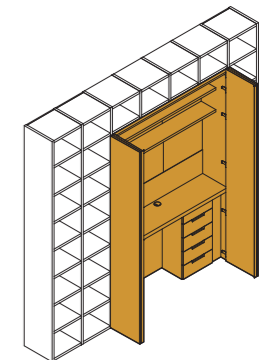

Chiusura pieghevole  
Folding closing system

p. 100-101



### ◀ soluzione 2 / solution 2

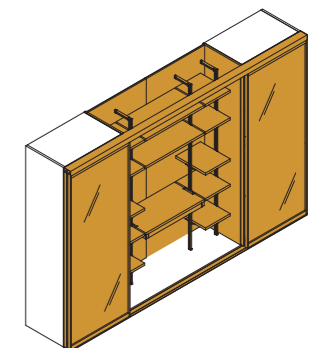

Chiusura scorrevole  
Sliding closing system

**Volumi a tutt'altezza per un'efficienza progettuale totale.**  
Full-height storage for total design efficiency.



▼ **Dettaglio dell'organizzazione interna con vano per robot aspirapolvere.**  
Detail of internal organization with robot vacuum garage.



**elementi** / elements

**armadio battente**  
hinged door wardrobe

**finiture** / finishes

**basalto** / basalto  
**nuvola** / nuvola



**Soluzioni su misura per ogni necessità.**  
Custom solutions for every need.



**elementi / elements**

**basi a terra**  
floorstanding base units  
**pensili / wall units**  
**casellari metallici**  
metal shelving units  
**piano sp. 5 cm**  
5cm-thick top

**finiture / finishes**

**nuvola / nuvola**  
**salvia / salvia**  
**noce naturale / noce naturale**



**elementi / elements**

**basi a terra**  
floorstanding base units  
**pensili / wall units**  
**boiserie Arnad**  
Arnad wall panelling

**finiture / finishes**

**cemento / cemento**  
**intonaco / intonaco**

**elementi / elements**

**pensili / wall units**  
**casellario metallico**  
metal shelving unit  
**boiserie Arnad**  
Arnad wall panelling  
**pedana sp. 8,7 cm**  
8,7cm-thick plinth

**finiture / finishes**

**moka / moka**  
**toulipier / toulipier**

## Ripostiglio: organizzare con ordine.

Hall cupboard: a neat way to organize.

**Nel progetto domestico, anche il ripostiglio può diventare un'utile risorsa progettuale, capace di offrire ordine e funzionalità senza alterare l'equilibrio estetico dell'ambiente. Inserito all'interno di volumi integrati o celato da chiusure continue, questo spazio risponde alle esigenze pratiche del quotidiano, accogliendo tutto ciò che si desidera avere a portata di mano ma lontano dallo sguardo.**

When it comes to interior design, even the hall cupboard can be a useful part of the puzzle, designed to offer order and functionality without upsetting the space's aesthetic balance. Whether built into an alcove or hidden behind a run of doors, this space caters to the practical demands of everyday life, providing a home for everything you want close to hand but out of sight.



**elementi** / elements

**armadio battente** / hinged door wardrobe

**boiserie Cover** / Cover wall panelling

**ripiani sp. 3 cm** / 3cm shelves

**base in sovrapposizione** / base unit sitting on plinth

**pedana h 3,7 cm** / 3,7cm-high plinth

**finiture** / finishes

**noce naturale** / noce naturale

**salvia** / salvia

**nuvola** / nuvola

▼ **Dettaglio degli elementi estraibili: vaschette, sacca e portascarpe.**  
Detail of pull-out accessories: caddies, hampers and shoe racks.



**Ripostiglio funzionale con chiusura pieghevole integrata.**  
Functional hall cupboard with fitted folding closing system.



elementi / elements

**armadio battente** / hinged door wardrobe  
**terminale libreria** / bookcase end unit  
**chiusura pieghevole** / folding closing system  
**boiserie Cover** / Cover wall panelling  
**ganci appendiabiti** / coat hooks  
**contenitore Toledo** / Toledo unit

finiture / finishes

**blu navy** / blu navy  
**brunito** / bronze  
**canapa** / canapa  
**specchio chiaro** / light mirror

▼ **Dettaglio del contenitore Toledo.**  
Detail of Toledo unit.



Apertura totale per un ordine essenziale e a portata di mano.  
Full opening for essential order and easy access.





**Funzionalità integrata su tutta la parete.**  
Fitted wall-to-wall functionality.



**elementi / elements**

**armadio battente / hinged door wardrobe**  
**boiserie Arnad / Arnad wall panelling**

**finiture / finishes**

**intonaco / intonaco**  
**nuvola / nuvola**

▼ **Dettaglio dell'asse da stiro estraibile.**  
Detail of pull-out ironing board.



**stanze accessorie**  
bonus rooms

# Personalizza gli spazi: scegli la stanza adatta alle tue necessità.

Personalize your spaces:  
choose the room that speaks  
to your needs.

## 08 - spazio per le passioni quotidiane / space for daily hobbies

---



pag. 122

## 10 - postazione operativa in ambiente dedicato / workstation in dedicated office space

---



pag. 140

## 09 - comfort e praticità per gli ospiti / comfort and practicality for guests

---



pag. 130

# Spazio per le passioni quotidiane.

Space for daily hobbies.

In uno spazio pensato per le attività individuali, l'arredo si adatta con discrezione alle passioni personali. Che si tratti di una palestra domestica, un angolo lettura, un'area dedicata alla musica o a progetti creativi, ogni composizione è studiata per organizzare al meglio volumi e funzioni, garantendo efficienza d'uso e ordine visivo. Sistemi modulari e contenitori tecnici si integrano con naturalezza, offrendo soluzioni su misura capaci di coniugare praticità e coerenza estetica.

A space tailored to individual lifestyles, with unobtrusive furniture chosen to align with your personal passions. Whether it's a home gym, a reading nook, a music room or a craft area, each configuration is designed to organize functions and the available space in the best way possible, resulting in efficient use and a sense of visual order. Modular systems and storage for equipment come together effortlessly, offering custom solutions with a clever combination of practicality and aesthetic cohesion.





**elementi / elements**

**boiserie Cover** / Cover wall panelling  
**componenti Cover** / Cover components  
**pedana sp. 8,7 cm** / 8,7cm-thick plinth  
**panca scendiletto in folding**  
 mitre-folded bed end bench  
**armadio battente** / hinged door wardrobe  
**terminale libreria** / bookcase end unit  
**pomoli appendiabiti** / clothes hanger knobs

**finiture / finishes**

**sabbia** / sabbia  
**toulipier** / toulipier  
**specchio chiaro** / light mirror  
**nuvola** / nuvola



**Le pareti si trasformano in libreria per una zona dedicata alla lettura.**  
Walls are turned into bookcases for a dedicated reading zone.



**elementi / elements**

**libreria a terra e sospesa** / floorstanding and wall-mounted bookcase  
**elementi Sudoku** / Sudoku units  
**scala scorrevole** / sliding ladder  
**armadio battente** / hinged door wardrobe  
**tavolino Porto** / Porto side table  
**divano Panama** / Panama sofa

**finiture / finishes**

**noce naturale** / noce naturale  
**salvia** / salvia  
**nuvola** / nuvola  
**grafite** / grafite  
**lavagna** / lavagna  
**chanel CR10** / chanel CR10



▼ **Dettaglio della chaise longue Panama e tavolino Porto.**  
Detail of Panama chaise longue and Porto side table.





**Organizzazione rivista per ospitare la passione musicale.**  
An organizational makeover to accommodate musical passions.



**elementi / elements**

- libreria a terra /** floorstanding bookcase
- armadio ponte /** bridging wardrobe
- moduli sottoponte con ante**  
modules under bridging unit with doors
- basi armadio /** wardrobe base units
- piano sp. 5 cm /** 5cm-thick top
- terminale libreria /** bookcase end unit
- boiserie imbottita Arnad /** Arnad padded wall panelling
- divano Panama /** Panama sofa

**finiture / finishes**

- calce /** calce
- cemento /** cemento
- lavagna /** lavagna
- vetro fumé /** smoked glass
- daisy CQ60 /** daisy CQ60
- aster CG10 /** aster CG10

**Doppia interpretazione dello spazio per esigenze diverse.**  
Two takes on the same space cater to different requirements.

◀ **soluzione 1 / solution 1**

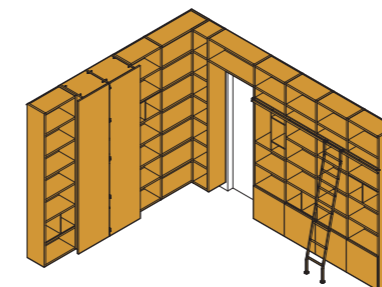

▶ **soluzione 2 / solution 2**

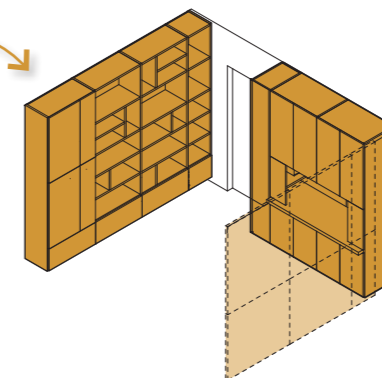

p. 126-127

▼ **Dettaglio del terminale libreria.**  
Detail of bookcase end unit.



# Comfort e praticità per gli ospiti.

Comfort and practicality  
for guests.

Quando l'esigenza di accogliere un ospite si presenta all'improvviso, lo spazio si adatta con soluzioni trasformabili e integrate. Un posto letto in più prende forma all'interno di composizioni compatte e multifunzione, pensate per offrire massima praticità senza compromettere l'ordine visivo. L'arredo si trasforma solo quando serve, mantenendo leggerezza e coerenza estetica in ogni situazione.

When you suddenly find yourself needing to accommodate a guest, the space adapts accordingly with built-in convertible solutions. Designed to deliver ultimate practicality without compromising visual order, these compact, multi-tasking configurations can produce an extra bed when required. The furniture only converts when the need arises, retaining a light and cohesive look no matter what the situation.



**Libreria attrezzata con letto ribaltabile.**  
Bookcase incorporating drop-down bed.



**elementi / elements**

**libreria a terra e sospesa** / floorstanding and wall-mounted bookcase  
**libreria con letto ribaltabile** / bookcase with drop-down bed  
**boiserie Arnad** / Arnad wall panelling  
**testiera Cardiff** / Cardiff headboard  
**divano Madrid** / Madrid sofa  
**tavolino Orig** / Orig side table  
**piano sospeso sp. 5 cm con alzata** / 5cm-thick wall-mounted top with upstand  
**sedia Montreal** / Montreal chair

**finiture / finishes**

**moka** / moka  
**noce naturale** / noce naturale  
**sabbia** / sabbia  
**lily CD42** / lily CD42  
**TL49** / TL49

▼ **Dettaglio della composizione divano Panama.**  
Detail of Panama sofa setting.



**Organizzazione verticale e soluzione salvaspazio.**  
Vertical organization and space-saving solution.



**elementi / elements**

**libreria a terra** / floorstanding bookcase  
**libreria con letto ribaltabile** / bookcase with drop-down bed  
**pouf Austin** / Austin ottoman  
**armadio battente** / hinged door wardrobe  
**moduli sovrapponibili** / stackable modules

**finiture / finishes**

**nuvola** / nuvola  
**toulipier** / toulipier  
**specchio chiaro** / light mirror  
**aida CJ04** / aida CJ04

▼ **Dettaglio del modulo sovrapponibile.**  
Detail of stackable module.



Letto integrato, nascosto e funzionale.  
Concealed and functional built-in bed.



**Massima funzionalità, minimo ingombro.**  
Big on function, small in footprint.



**elementi / elements**

**libreria a terra e sospesa**  
floorstanding and wall-mounted bookcase  
**libreria con letto ribaltabile**  
bookcase with drop-down bed  
**boiserie Arnad** / Arnad wall panelling  
**specchio per boiserie**  
mirror for wall panelling  
**piano sp. 5 cm** / 5cm-thick top  
**sedia Cannes imbottita**  
upholstered Cannes chair  
**pouf Hanoi** / Hanoi ottoman  
**armadio battente** / hinged door wardrobe  
**armadio ponte** / bridging wardrobe  
**boiserie Cover** / Cover wall panelling  
**mensole ad L** / L-shaped shelf  
**contenitore Toledo con asse da stiro**  
Toledo unit with ironing board  
**ganci appendiabiti** / coat hooks

**finiture / finishes**

**cashmere** / cashmere  
**gesso** / gesso  
**lavagna** / lavagna  
**juta** / juta  
**vetro fumé** / smoked glass  
**brunito** / bronze  
**aida CJ05** / aida CJ05  
**TL50** / TL50

▼ **Dettaglio del contenitore Toledo.**  
Detail of Toledo unit.



## Postazione operativa in area dedicata.

Workstation in  
dedicated office area.

**Nello spazio home office, dove concentrazione e funzionalità si incontrano, ogni elemento contribuisce a creare un ambiente ordinato e operativo. Scrivanie, sedute ergonomiche e soluzioni per il contenimento si integrano con naturalezza in composizioni studiate per ottimizzare lo spazio e favorire la produttività. Modularità e personalizzazione permettono di adattare l'arredo alle diverse esigenze, mantenendo coerenza estetica e comfort quotidiano.**

In a home office, where focus meets functionality, every element has a part to play in creating a tidy and efficient work space. Desks, ergonomic seating and storage solutions come together effortlessly in configurations designed to optimize the space and foster productivity. The modular design and custom options mean furniture can be tailored to different requirements, maintaining a cohesive look and comfort for everyday tasks.



**Parete attrezzata e madia su gambe per un arredo leggero e funzionale.**  
Storage wall and sideboard on legs for a light and functional interior scheme.



**elementi / elements**

**libreria a terra e sovrapposta**  
floorstanding and sit-on-top bookcase  
**basi a terra** / floorstanding base units

**piano scrivania sp. 5 cm con gambe Linea**  
5cm-thick desk top with Linea legs

**sedia Nice** / Nice chair

**sedia Sneek lounge** / Sneek lounge chair

**favolino Porto** / Porto side table

**panca con gambe metalliche** / bench with metal legs

**basi in sovrapposizione** / base units sitting on plinth

**casellario metallico** / metal shelving unit

**finiture / finishes**

**bianco** / bianco

**toulipier** / toulipier

**vetro trasparente** / transparent glass

**bianco** / bianco

**salvia** / salvia

**toulipier** / toulipier

**vetro trasparente** / transparent glass

**larissa CP66** / larissa CP66

**TL49** / TL49



▼ **Dettaglio del cassettone h 36,3 cm.**  
Detail of 36,3cm-high oversized drawer.



**Equilibrio visivo tra pieni, vuoti e trasparenze.**  
Solid elements, voids and transparency for visual balance.



**elementi / elements**

**libreria a terra e sospesa**  
floorstanding and wall-mounted bookcase  
**boiserie Arnad / Arnad wall panelling**

**finiture / finishes**

**basalto / basalto**  
**gesso / gesso**



**elementi / elements**

**libreria con gambe metalliche**  
bookcase with metal legs

**finiture / finishes**

**cashmere / cashmere**  
**lavagna / lavagna**  
**vetro fumé / smoked glass**

**Home office simmetrico per un'estetica ordinata ed elegante.**

Symmetrical home office for an elegant and clutter-free look.

▼ **Dettaglio del sistema Uniko.**  
Detail of the Uniko system.



**elementi / elements**

**armadio battente /** hinged door wardrobe

**piano in appoggio sp. 5 cm con fianchi a terra**  
5cm-thick top sitting on floorstanding side panels

**sedia Cannes imbottita /** upholstered Cannes chair

**pouf Austin /** Austin ottoman

**sistema Uniko /** Uniko system

**finiture / finishes**

**sabbia /** sabbia

**noce naturale /** noce naturale

**bianco /** bianco

**noce naturale /** noce naturale

**nero /** nero

**TL47 /** TL47

**paloma CB05 /** paloma CB05



**pertinenze domestiche**  
ancillary spaces

# Ordine e funzione nei tuoi spazi tecnici: trova la soluzione adatta a te.

Order and function in your utilitarian spaces: find the best solution for you.

## 11 - arredo funzionale per il garage / functional fitout for the garage

---



pag. 154



pag. 162

## 12 - spazi tecnici da vivere / utilitarian spaces to be enjoyed

---



pag. 168



pag. 176

## Arredo funzionale per il garage.

Functional fitout for the garage.

Anche il garage può diventare un ambiente pienamente progettato, dove ogni elemento trova il suo posto e contribuisce all'ordine generale della casa. Spesso considerato un semplice spazio di servizio, il garage rivela il suo potenziale attraverso soluzioni d'arredo, pensate per contenere, organizzare e supportare le attività quotidiane. Composizioni integrate e su misura si inseriscono con naturalezza, trasformando il vano tecnico in una zona operativa funzionale e ordinata.

Even the garage can be turned into a properly designed room, where every element has its place and contributes to the home's general organization. Often relegated to the status of a mere service space, the garage reveals its true potential with the use of clever furniture solutions designed to organize, provide storage and help with everyday activities. Custom built-in configurations blend effortlessly into their setting, turning the utilitarian space into a functional and well-ordered work zone.



Librerie: organizzazione e contenimento.  
Bookcases: organization and storage.



elementi / elements

libreria con gambe metalliche  
bookcase with metal legs

finiture / finishes

intonaco / intonaco  
lavagna / lavagna



**Boiserie Cover: estetica e funzione per le pareti.**  
Cover wall panelling: form and function for your walls.



**elementi / elements**

libreria a terra / floorstanding bookcase  
 libreria ponte / bridging bookcase  
 boiserie Cover / Cover wall panelling  
 componenti Cover / Cover components  
 tavolo ribaltabile / drop-down table  
 ganci appendiabiti / coat hooks

**finiture / finishes**

calce / calce  
 gesso / gesso  
 brunito / bronze

▼ **Dettaglio del tavolo ribaltabile.**  
Detail of drop-down table.



**Equilibrio tra contenimento a vista e funzionalità.**  
A balanced combination of open storage and functionality.



**elementi / elements**

**cabina cremagliera / slotted rail walk-in closet**

**armadio battente / hinged door wardrobe**

**modulo con tavolo estraibile / module with pull-out table**

**modulo angolo lineare / straight corner unit**

**finiture / finishes**

**basalto / basalto**

**moka / moka**

**nuvola / nuvola**

**noce naturale / noce naturale**

▼ **Dettaglio del tavolo estraibile.**  
Detail of pull-out table.



**Una postazione operativa  
che sfrutta l'angolo.**  
A workstation that makes use  
of dead corner space.



▼ **Dettaglio degli elementi Cover.**  
Detail of Cover units.



**elementi / elements**

**basi a terra / floorstanding base units**  
**pensili / wall units**  
**boiserie Cover / Cover wall panelling**  
**componenti Cover / Cover components**  
**piano in appoggio sp. 5 cm con fianco a terra**  
5cm-thick top sitting on floorstanding side panel  
**sgabello Cusco / Cusco stool**

**sistema Uniko / Uniko system**

**finiture / finishes**

**lavagna / lavagna**  
**nuvola / nuvola**  
**noce naturale / noce naturale**  
**nero / nero**  
**TL48 / TL48**  
**lavagna / lavagna**

**Piano operativo integrato nella composizione.**  
Worktop built into the configuration.



**elementi / elements**

**armadio battente /** hinged door wardrobe  
**moduli sovrapponibili /** stackable modules  
**armadio ponte /** bridging wardrobe  
**piano in appoggio sp. 5 cm con fianco a terra**  
5cm-thick top sitting on floorstanding side panel  
**sedia Cork /** Cork chair  
**cassettiere su ruote /** drawer units on castors  
**mensole Slim /** Slim shelves

**finiture / finishes**

**bianco /** bianco  
**cemento /** cemento  
**nuvola /** nuvola  
**toulipier /** toulipier  
**J00 /** J00  
**cemento /** cemento  
**toulipier /** toulipier





**Struttura sospesa per leggerezza e praticità.**  
Wall-mounted structure for practicality and a light look.



**elementi** / elements

**basi in sovrapposizione** / base units sitting on plinth  
**panche con gambe metalliche** / benches with metal legs  
**pensili** / wall units  
**boiserie Arnad** / Arnad wall panelling  
**piano sp. 3 cm** / 3cm-thick top  
**cassettiera su ruote** / drawer unit on castors  
**sgabello Goa** / Goa stool

**finiture** / finishes

**canapa** / canapa  
**lavagna** / lavagna  
**salvia** / salvia  
**nero** / nero  
**TL48** / TL48

## Spazi tecnici da vivere.

Utilitarian spaces  
to be enjoyed.

Anche nelle aree più tecniche della casa, dove funzionalità e praticità sono imprescindibili, l'arredo può fare la differenza. Spazi come cantine o locali caldaia trovano nel sistema Cinquanta3 una risposta progettuale capace di unire organizzazione e ordine visivo. Componibilità flessibile e soluzioni ben integrate permettono di gestire al meglio ogni volume, garantendo continuità stilistica e coerenza con il resto della casa.

The right furniture can make all the difference even in the home's most utilitarian spaces, where functionality and practicality are must-haves. The Cinquanta3 system caters to spaces like basements or plant rooms with designs that provide both organization and a visual sense of order. A flexible modular design and fully built-in solutions allow you to make the best use of all available space, ensuring continuity of style and cohesion with the rest of the home.



Una cantina attrezzata per essere vissuta ogni giorno.  
A basement fitted out for everyday enjoyment.

**elementi / elements**

**libreria a terra e sospesa**  
floorstanding and wall-mounted bookcase

**basi a terra / floorstanding base units**

**top per lavabo / sink top**

**lavabo da incasso / drop-in sink**

**base lavabo / sink base unit**

**piano in appoggio sp. 5 cm con fianchi a terra**

5cm-thick top sitting on floorstanding side panels

**sgabelli Kyoto / Kyoto stools**

**finiture / finishes**

**noce naturale / noce naturale**

**lavagna / lavagna**

**vetro fumé / smoked glass**

**bianco / bianco**

**noce naturale / noce naturale**

**bianco / bianco**

**J00 / J00**

**Stessi volumi, diversa interpretazione d'uso e stile.**  
Same space, different take in terms of use and style.



**elementi / elements**

**armadio battente** / hinged door wardrobe  
**sistema Uniko** / Uniko system  
**armadio ponte** / bridging wardrobe  
**basi armadio** / wardrobe base units  
**boiserie Arnad** / Arnad wall panelling  
**mensola sp. 3 cm con LED** / 3cm-thick shelf with LED  
**tavolo Leone Large** / Leone Large table  
**piani in appoggio sp. 5 cm con fianchi a terra**  
5cm-thick tops sitting on floorstanding side panels  
**seduta imbottita** / padded seat

**finiture / finishes**

**sabbia** / sabbia  
**lavagna** / lavagna  
**rovere cotto** / rovere cotto  
**vetro fumé** / smoked glass  
**juta** / juta  
**lavagna** / lavagna  
**rovere cotto** / rovere cotto  
**chanel CR70** / chanel CR70



**Un ambiente conviviale, con un'estetica elegante.**  
 An entertaining space with an elegant look.



▼ **Dettaglio dell'interno base.**  
 Detail of inside of base unit.



**elementi / elements**

- basi a terra**  
floorstanding base units
- boiserie Cover**  
Cover wall panelling
- mensole Slim / Slim shelves**
- armadio battente**  
hinged door wardrobe
- pensile / wall unit**
- piano sp. 5 cm con gambe Linea**  
5cm top with Linea legs
- sedie Cannes imbottite**  
upholstered Cannes chairs

**finiture / finishes**

- moka / moka**
- nuvola / nuvola**
- canapa / canapa**
- lavagna / lavagna**
- nero / nero**
- TL49 / TL49**

## Organizzazione e praticità anche nei locali tecnici.

Even mechanical rooms are elevated with organization and practicality.

▼ **Dettaglio del piano in appoggio con fianco a terra.**  
Detail of top sitting on floorstanding side panel.



**elementi** / elements

**armadio scorrevole** / sliding door wardrobe  
**cabina cremagliera** / slotted rail walk-in closet

**top per lavabo con fianco a terra**  
sink top with floorstanding side panel

**base lavabo** / sink base unit

**finiture** / finishes

**bianco** / bianco  
**nuvola** / nuvola

**bianco** / bianco



**Alternative compositive per attrezzare la parete.**  
Alternative configuration options for functional storage walls.



**elementi / elements**  
**sistema Uniko / Uniko system**

**finiture / finishes**  
**lavagna / lavagna**  
**cemento / cemento**



**elementi / elements**  
**libreria con gambe metalliche**  
bookcase with metal legs  
**libreria sospesa**  
wall-mounted bookcase

**finiture / finishes**  
**bianco / bianco**  
**gesso / gesso**

**il progetto Cinquanta3**  
the Cinquanta3 project

Ogni ambiente, dalla casa agli spazi pubblici, è pensato per rispondere in modo efficace e flessibile alle necessità quotidiane.

La libertà progettuale diventa lo strumento per creare contesti versatili, accoglienti e coerenti, in cui funzionalità ed estetica si integrano con naturalezza. Dagli ambienti di servizio alle camere, dall'ingresso alla zona living, fino agli spazi destinati all'accoglienza o all'attività professionale, tutto è concepito per adattarsi a diverse modalità d'uso, offrendo soluzioni pratiche e su misura.

Every interior, from the home to public spaces, has been designed to cater to daily needs effectively and flexibly. Design freedom becomes the perfect tool for creating versatile, welcoming and cohesive settings, wherein form and function merge effortlessly. From utility areas to bedrooms, from the entrance to the living area, all the way through to hospitality or professional business settings, everything has been conceived to accommodate different ways of using the space, offering practical solutions tailored to individual requirements.

## Life spaces

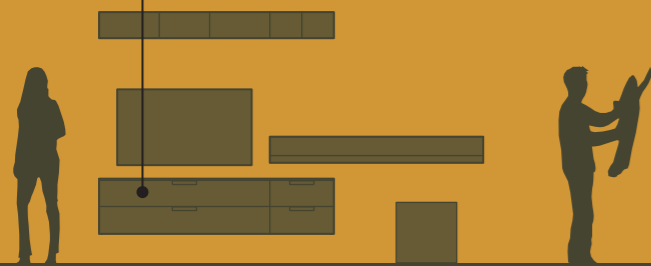

### spazi di vita

**ingresso** / entrance  
**soggiorno** / living room  
**camera** / bedroom

## Service spaces



### spazi di servizio

**dispensa** / pantry  
**lavanderia** / laundry  
**garage** / garage  
**ripostiglio** / walk-in cupboard  
**disimpegno** / vestibule  
**stanza accessoria** / bonus room

## Work spaces



### spazi di lavoro

**uffici** / offices  
**spazi commerciali** / commercial spaces  
**negozi** / stores

## Hospitality spaces



### spazi di ricezione

**hotel** / hotels  
**apart-hotel** / serviced apartment  
**ristorazione** / food services

## Credits

creative and design director

**Valeria Carlesso**

communication concept and graphic design

**grucciadesign.**

project and set design

**cinquanta3 studio**

digital images

**Helios Digital**

colour separation

**Lucegroup**

print

**Ingrel Srl**

October 2025



The mark of  
responsible forestry

Richiedi a [info@cinquanta3.it](mailto:info@cinquanta3.it)  
se il prodotto a cui sei  
interessato è certificato FSC®.

Ask [info@cinquanta3.it](mailto:info@cinquanta3.it) if the  
product you are interested in  
is FSC® certified.



via G. Galilei 35  
31053 Pieve di Soligo  
Treviso - Italia  
T +39 0438 83 93  
[info@cinquanta3.it](mailto:info@cinquanta3.it)  
[cinquanta3.it](http://cinquanta3.it)

**Battistella spa si riserva in qualsiasi momento la facoltà di apportare tutte le modifiche necessarie al miglioramento funzionale e qualitativo dei propri prodotti. Per ogni aspetto tecnico e dimensionale fare riferimento ai listini aziendali e relativi aggiornamenti. I colori e i materiali riprodotti nelle immagini stampate hanno un valore indicativo. Battistella spa declina ogni responsabilità derivante da eventuali inesattezze di stampa e/o da errori sulle caratteristiche dei prodotti forniti.**

In line with its policy of improving product function and quality, Battistella spa reserves the right to make any necessary changes at any time. For information of a technical and dimensional nature, refer to the company price lists and relevant updates. The colours and materials reproduced in the images printed herein are given as an approximate guide only. Battistella spa does not accept any responsibility for misprints and/or mistakes in describing the characteristics of the products supplied.

