

CONTENITORI BASI / BASE STORAGE UNITS

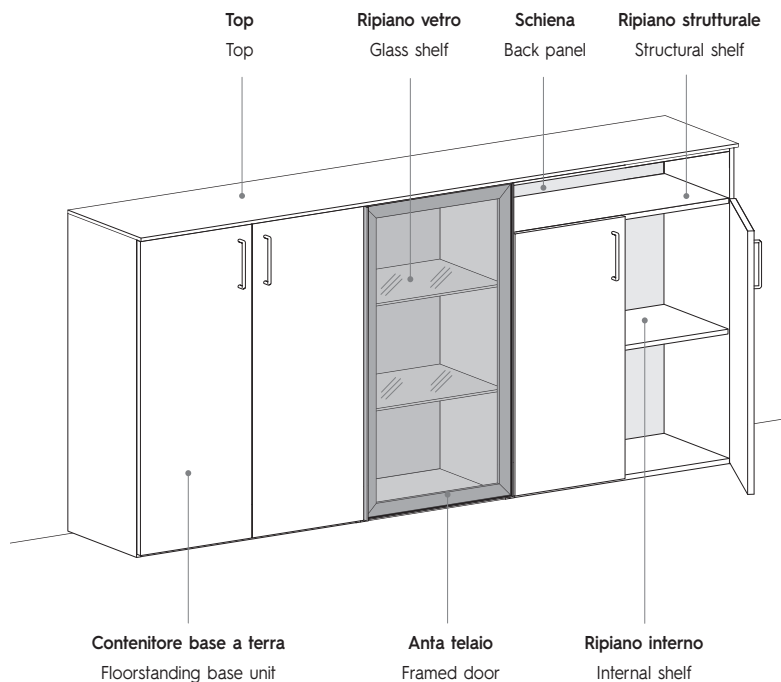

PORTATA FONDO CASSETTI DRAWER BOTTOM LOAD CAPACITY

| | L./W 45 | L./W 60 | L./W 75 | L./W 90 | L./W 120 |
|-----------|---------|---------|---------|---------|----------|
| P./D 35,4 | 15 kg | 15 kg | 15 kg | 13 kg | 12 kg |
| P./D 45,4 | 15 kg | 15 kg | 15 kg * | 13 kg * | 11 kg * |
| P./D 60,6 | 15 kg | 15 kg | 15 kg * | 13 kg * | 10 kg * |

* fondo con rinforzo
* reinforced bottom

Base in appoggio Sit-on-top base unit

con feltrini
with felt pads

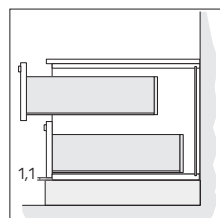

Base a terra Floorstanding base unit

con piedini regolabili H 0,7 cm
with 0,7cm-high adjustable feet

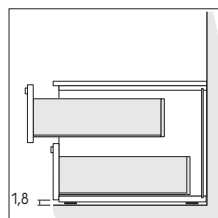

Base sospesa Wall-mounted base unit

con attaccaglie pesanti
with heavy hanging brackets.

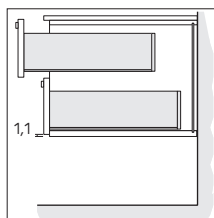

Note per montaggio

I contenitori del programma Cinquanta3 vengono consegnati montati.

Note per la sicurezza

L'apertura contemporanea delle ante o dei cassetti di una base a terra o in appoggio può causarne il ribaltamento. Consigliamo quindi il fissaggio a muro.

Assicurarsi che la parete sia idonea a sostenere il peso delle basi sospese, le quali non devono essere soggette a carichi eccessivi.

Si raccomanda di eseguire la foratura con sistema a sola rotazione (non a percussione) e successivamente un'accurata pulizia del foro prima dell'installazione.

È importante verificare sempre le condizioni e la tenuta dei muri. Le basi sospese non possono essere installate su pareti divisorie, in cartongesso o comunque su pareti non portanti.

Assembly notes

The Cinquanta3 system's storage units come ready assembled.

Notes on safety

Opening all the doors or drawers at the same time on a floorstanding or sit-on-top base unit may cause it to tip over. Hence we recommend fastening it to the wall.

Make sure that the wall is strong enough to take the weight of wall-mounted base units, which must not be subjected to excessive loads.

Make sure you drill holes using rotation only (no percussion system) and then clean the hole thoroughly before installing units.

It is important to always check the state and soundness of walls. Wall-mounted base units cannot be installed on partition walls, stud walls or any wall that is not load bearing.

CONTENITORI BASI / BASE STORAGE UNITS

ALTEZZE / HEIGHTS

da completare con top sp. 1,2 o 3 cm.
to be finished off with 1,2cm- or 3cm-thick top.

CONTENITORI BASI A TERRA FLOORSTANDING BASE UNITS

Altezza comprensiva di piedino regolabile H. 0,7 cm.
Height includes 0,7cm-high adjustable foot.

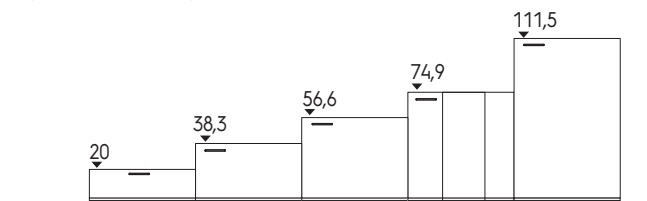

CONTENITORI BASI IN APPOGGIO O SOSPESI SIT-ON-TOP OR WALL-MOUNTED BASE UNITS

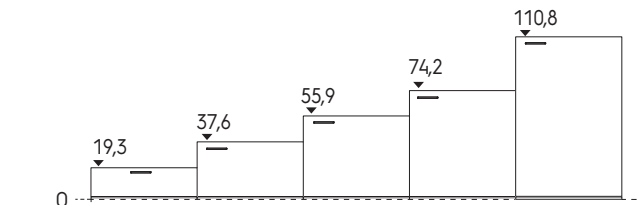

LARGHEZZA E PROFONDITÀ / WIDTHS AND DEPTHS

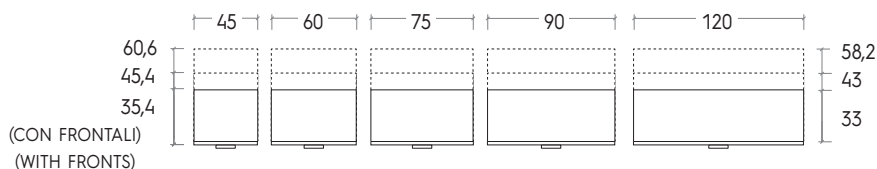

ANGOLO / CORNER UNIT

Prof. 35,4 cm
Depth 35,4 cm

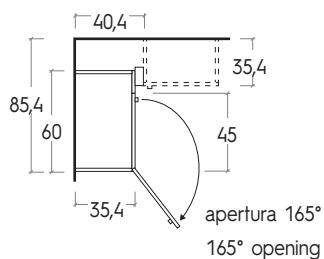

Prof. 45,4 cm
Depth 45,4 cm

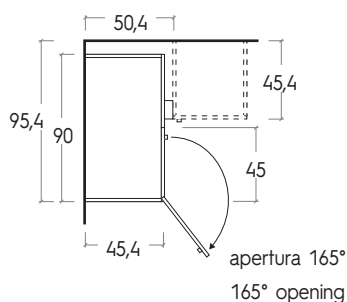

Prof. 60,6 cm
Depth 60,6 cm

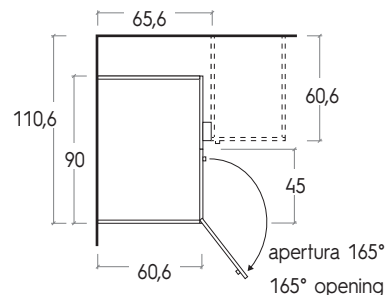

ANGOLO CON CAMBIO PROFONDITÀ / CORNER UNIT WITH DIFFERENT DEPTHS

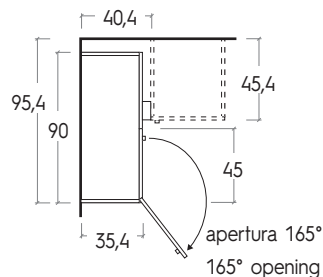
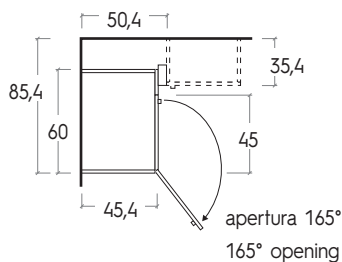

CONTENITORI BASI / BASE STORAGE UNITS

BASI SCHEDARIO - con cassettoni portacartelle

FILING DRAWER BASE UNITS - with filing drawers

In presenza di portacartelle il contenitore base va ancorato al muro con la ferramenta in dotazione.

When a hanging folder system is involved, the base storage unit must be secured to the wall with the hardware provided.

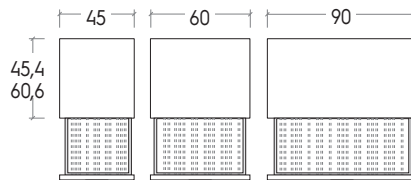

BASE CON TAVOLO ESTRAIBILE

BASE UNIT WITH PULL-OUT TABLE

3 allunghe da 40 cm. Si consiglia il fissaggio a muro.

Three 40cm extension leaves. We recommend fastening to the wall.

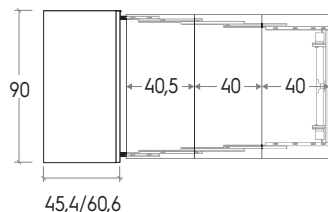
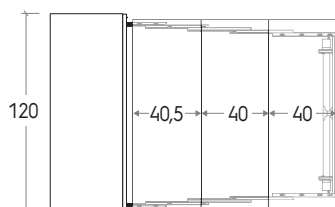
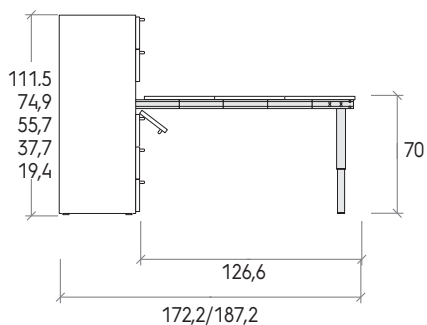

BASE CON ASSE DA STIRO ESTRAIBILE

BASE UNIT WITH PULL-OUT IRONING BOARD

Si consiglia il fissaggio a muro.

We recommend fastening to the wall.

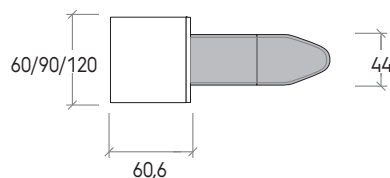
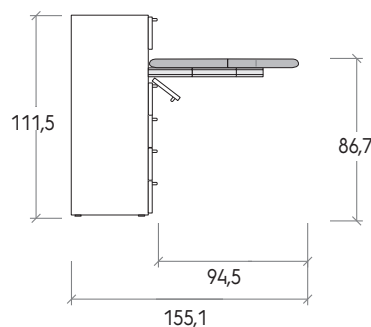

CASSETTI E CASSETTONI

REGULAR and OVERSIZED DRAWERS

Dimensioni interne.

Internal dimensions.

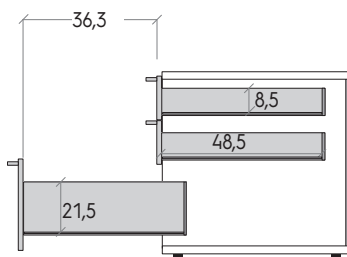
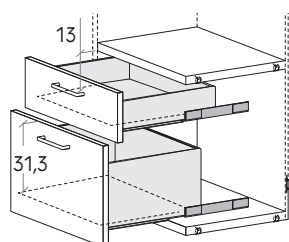

Profondità 60,6 cm
Depth 60,6 cm

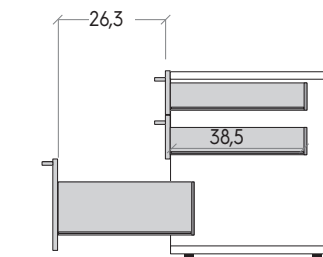

Profondità 45,4 cm
Depth 45,4 cm

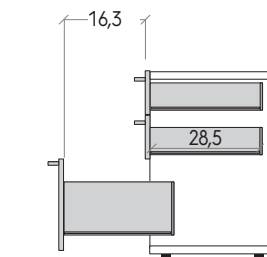

Profondità 35,4 cm
Depth 35,4 cm

CONTENITORI BASI / BASE STORAGE UNITS

TIPOLOGIA FRONTALI
FRONT TYPES

Misure in cm.
Dimensions in cm.

Frontali LISCI LISCIA fronts

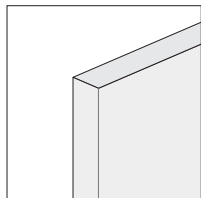

ANTE BATTENTI
HINGED DOORS

Altezze/ Heights

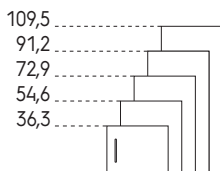

Larghezze / Widths

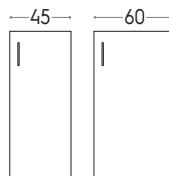

RIALZE/RIBALTE
LIFT-UP/PULL-DOWN
DOORS

Altezze/ Heights

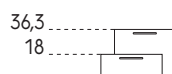

Larghezze / Widths



Spessore / Thickness

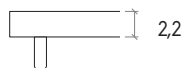

CASSETTI/CASSETTONI
REGULAR/OVERSIZED
DRAWERS

Altezze/ Heights

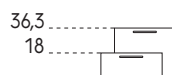

Larghezze / Widths



Frontali GOLLA GOLA fronts

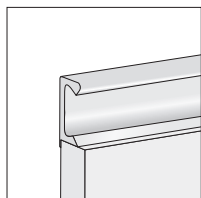
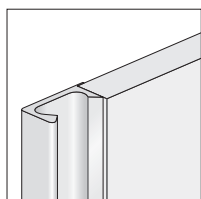

ANTE BATTENTI
HINGED DOORS

Altezze/ Heights

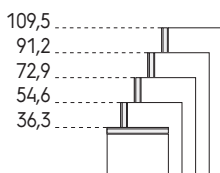

Larghezze / Widths

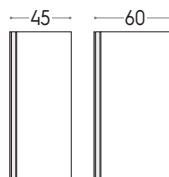

RIALZE/RIBALTE
LIFT-UP/PULL-DOWN
DOORS

Altezze/ Heights



Larghezze / Widths



Spessore / Thickness

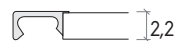

CASSETTI/CASSETTONI
REGULAR/OVERSIZED
DRAWERS

Altezze/ Heights



Larghezze / Widths



Anta telaio Framed door

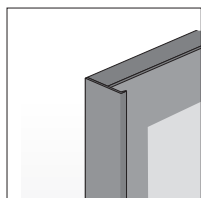

ANTE BATTENTI
HINGED DOORS

Altezze/ Heights

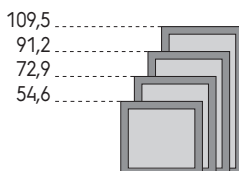

Larghezze / Widths

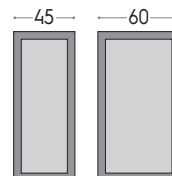

RIALZE/RIBALTE
LIFT-UP/PULL-DOWN
DOORS

Altezze/ Heights

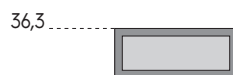

Larghezze / Widths



Spessore / Thickness



CONTENITORI BASI / BASE STORAGE UNITS

COMPONENTI ATTREZZATURA ESTRAIBILE - Utilizzabili all'interno di contenitori P. 60,6 cm.

PULL-OUT FITTING COMPONENTS - For use inside 60,6cm-deep storage units.

Telaio estraibile

Pull-out frame

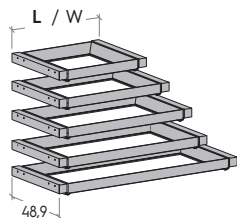

| L / W cm | L. utile Usable W |
|-------------|----------------------|
| 54,6 | 39,8 |
| 71,4 | 54,8 |
| 86,4 | 69,8 |
| 116,4 | 99,8 |

Piano per vassoio

Tray bottom

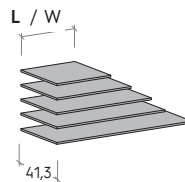

| L / W cm |
|-------------|
| 39,8 |
| 54,8 |
| 69,8 |
| 79,8 |
| 99,8 |

Portacravatte per piano vassoio

Tie organizer for tray bottom

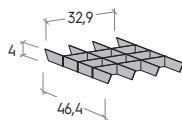

Aste portapantalone

Trouser rack rods

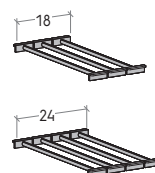

kit 3 aste / 3-rod kit
kit 4 aste / 4-rod kit

Vaschetta metallica

Metal caddy

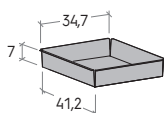

Scarpiera in metallo

Metal shoe rack

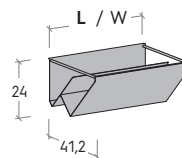

| L / W cm |
|-------------|
| 52,7 |
| 67,7 |

Sacca piccola in tessuto

Small fabric bag

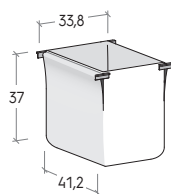

Sacca grande in tessuto

Large fabric bag



Stendibiancheria

Laundry drying rack

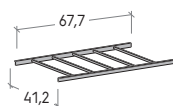

Vassoio raccogliocce

Drip tray

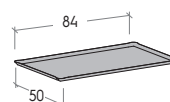

CONTENITORI BASI / BASE STORAGE UNITS

ATTREZZATURA ESTRAIBILE - Utilizzabili all'interno di contenitori P. 60,6 cm.

PULL-OUT FITTINGS - For use inside 60,6cm-deep storage units.

Portapantaloni estraibile e stendibiancheria estraibile

Pull-out trouser rack and pull-out drying rack

Guide ad estrazione totale con chiusura ammortizzata.

Full-extension soft-close runners.

Non sono possibili riduzioni a misura.

No cutting to size is possible.

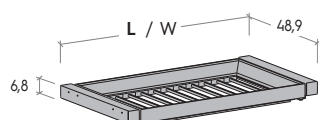

| Per L. For W cm | |
|-----------------------|-------------------|
| 60 | 6 aste / 6 rods |
| 90 | 11 aste / 11 rods |

| Per L. For W cm | |
|-----------------------|-----------------|
| 90 | 5 aste / 5 rods |

Stendibiancheria / Laundry drying rack

Vassoio estraibile

Pull-out tray

Guide ad estrazione totale con chiusura ammortizzata.

Full-extension soft-close runners.

Non sono possibili riduzioni a misura.

No cutting to size is possible.

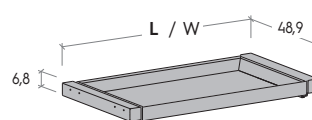

| Per L. For W cm |
|-----------------------|
| 60 |
| 75 |
| 90 |
| 120 |

Vaschette estraibili

Pull-out caddies

Guide ad estrazione totale con chiusura ammortizzata.

Full-extension soft-close runners.

Non sono possibili riduzioni a misura.

No cutting to size is possible.

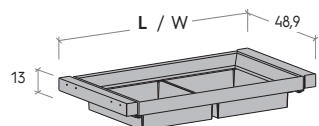

| Per L. For W cm | |
|-----------------------|------------------|
| 60 | 1 pz. / 1 unit |
| 90 | 2 pz. / set of 2 |

Portascarpe estraibile

Pull-out shoe rack

Guide ad estrazione totale con chiusura ammortizzata.

Full-extension soft-close runners.

Non sono possibili riduzioni a misura.

No cutting to size is possible.

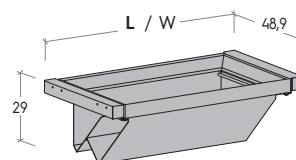

| Per L. For W cm |
|-----------------------|
| 90 |

Sacca piccola estraibile

Small pull-out hamper

Sacche rimovibili singolarmente.

Bags can be removed individually.

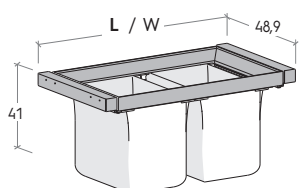

| Per L. For W cm | |
|-----------------------|------------------|
| 60 | 1 pz. / 1 unit |
| 90 | 2 pz. / set of 2 |

Sacca grande estraibile

Large pull-out hamper

Sacche rimovibili singolarmente.

Bags can be removed individually.

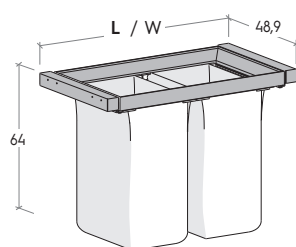

| Per L. For W cm | |
|-----------------------|------------------|
| 60 | 1 pz. / 1 unit |
| 90 | 2 pz. / set of 2 |